



# 5" Video Baby Monitor with Night Light

LF2415



## User Guide

This guide contains important information.  
Please keep it for future reference.

# Contents

<b>Important Safety Instructions</b> .....	<b>3</b>
<b>Setup</b> .....	<b>4</b>
What's Included? .....	4
Overview .....	5
Parent Viewer Icons .....	9
Connect the Baby Monitor .....	12
Charge the Parent Viewer Battery .....	13
Power On or Off the Baby Monitor.....	14
Position the Baby Monitor .....	15
<b>Basic Operation</b> .....	<b>16</b>
Talk to Your Baby via the Baby Unit.....	16
Use the Menu .....	17
Adjust Speaker Volume .....	18
Zoom.....	19
Turn on/off the Parent Viewer Screen.....	20
Adjust Screen Brightness .....	20
<b>Advanced Operation</b> .....	<b>21</b>
Lullabies and Soothing Sounds .....	21
Adjust Baby Unit Speaker Volume.....	21
Night Light.....	22
Set Screen off Timer .....	23
Adjust Sound Sensitivity Level.....	24
Turn on/off Alert Tones .....	25
Night Vision.....	27
Dim Mode .....	27
<b>Additional Information</b> .....	<b>28</b>
Wall Mount (Optional) .....	28
General Product Care.....	30
Storage .....	30
Adult Supervision.....	30
Technical Specifications.....	30
Disposal of Batteries and Product .....	31
Customer Service and Product Warranty .....	31
Declaration of Conformity .....	31

# Important Safety Instructions

The applied name plate is located at the bottom of the Baby Unit's base. When using your equipment, basic safety precautions should always be followed to reduce the risk of fire, electric shock and injury, including the following:

1. Follow all warnings and instructions marked on the product.
2. Adult setup is required.
3. **CAUTION:** Do not install the Baby Unit at a height above 2 metres.
4. This product is intended as an aid. It is not a substitute for responsible and proper adult supervision and should not be used as such.
5. This product is not intended for use as a medical monitor.
6. Do not use this product near water, for example, near to a bath, sink, swimming pool or shower.
7. **CAUTION:** Use only the battery provided. There may be a risk of explosion if a wrong type of battery is used for the Parent Viewer. The battery cannot be subjected to high or low extreme temperature and low air pressure at high altitude during use, storage or transportation. Disposal of battery in fire or a hot oven, mechanically crushing or cutting or the battery can result in an explosion. Leaving the battery in an extremely high temperature surrounding environment can result in an explosion or the leakage of flammable liquid or gas. Battery subjected to extremely low air pressure may result in an explosion or the leakage of flammable liquid or gas. Dispose of used batteries according to the instructions.
8. Use only the adaptors included with this product. Incorrect adaptor polarity or voltage can seriously damage the product. Use only the adaptors and battery listed below.



## Power adaptors information:

**Baby Unit Output: 5V DC 600mA;**  
**VTech Telecommunications Ltd.;**  
**Model: VT05EUK05060**  
**Parent Viewer Output: 5V DC 1A;**  
**VTech Telecommunications Ltd.;**  
**Model: VT05EUK05100**



## Rechargeable battery information:



**Zhuhai Great Power Energy Co., Ltd.**  
**Li-ion battery, 3.6V, 2600mAh, 9.36Wh;**  
**Model: ICR18650-2.6Ah-3.6V-1S1P**

9. The power adaptors are intended to be correctly oriented in a vertical or floor mount position. The prongs are not designed to hold the plug in place if it is plugged into a ceiling, under-the-table or cabinet outlet.
10. For pluggable equipment, the socket-outlet should be installed near the equipment and should be easily accessible.
11. Unplug this product from the wall outlet before cleaning.
12. Do not use liquid or aerosol cleaners. Use a damp cloth for cleaning. Do not modify the power adaptors or replace with other adaptors.
13. Do not allow anything to rest on the power cords. Do not install this product where the cords may be walked on or crimped.
14. This product should be operated only from the type of power source indicated on the marking label. If you are not sure of the type of power supply in your home, consult your dealer or electricity supply provider.

15. Do not overload wall outlets or use an extension cord.
16. Do not place this product on an unstable table, shelf, stand or other unstable surfaces.
17. This product should not be placed in any area where proper ventilation is not provided. Slots and openings in the back or bottom of this product are provided for ventilation. To protect them from overheating, these openings must not be blocked by placing the product on a soft surface such as a bed, sofa or rug. This product should never be placed near or over a radiator or heat source.
18. Never push objects of any kind into this product through the slots because they may touch dangerous voltage points or create a short circuit. Never spill liquid of any kind on the product.
19. To reduce the risk of electric shock, do not disassemble this product, but take it to an authorised service facility. Disassembling or removing parts of the product other than via the battery door may expose you to dangerous voltages or other risks. Incorrect reassembling can cause electric shock when the product is subsequently used.
20. You should test the sound reception every time you turn on the units or move one of the components.
21. Periodically examine all components for damage.
22. There is a very low risk of privacy loss when using certain electronic devices, such as baby monitors, cordless telephones, etc. **To protect your privacy, make sure the product has never been used before purchase, reset the baby monitor periodically by powering off and then powering on the units, and power off the baby monitor if you are not intending to use it for some time.**
23. Children should be supervised to ensure that they do not play with the product.
24. The small parts of this monitor can be swallowed by babies or small children. Keep these parts out of reach of children.
25. The product is not intended for use by persons (including children) with reduced physical, sensory or mental capabilities, or lack of experience and knowledge, unless they have been given supervision or instruction concerning use of the appliance by a person responsible for their safety.

## SAVE THESE INSTRUCTIONS

### Cautions

1. Use and store the product at a temperature between 0°C and 40°C.
2. Mishandling batteries can cause burn, fire or explosion hazards.
3. Do not expose the product to extreme cold, heat or direct sunlight. Do not put the product close to a heating source.
4. Batteries should not be exposed to excessive heat such as bright sunshine or fire.
5.  **Warning—Strangulation Hazard—** Children have STRANGLED in cords. Keep this cord out of the reach of children. Do not remove this Do not remove warning label on the adaptor cord. 
6. Never place the Baby Unit(s) inside the baby's cot or playpen. Never cover the Baby Unit(s) or Parent Viewer with anything such as a towel or a blanket.
7. Other electronic products may cause interference with your baby monitor. Try installing your baby monitor as far away from these electronic devices as possible: wireless routers, radios, cellular telephones, intercoms, room monitors, televisions, personal computers, kitchen appliances and cordless telephones.

# Setup

## What's Included?



**Parent Viewer**



**Parent Viewer Adaptor**



Learn to set up your units and have all detailed instructions on using your baby monitor.

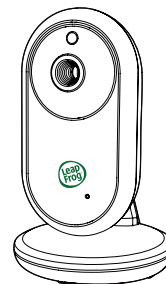

**Baby Unit**

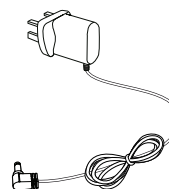

**Baby Unit Adaptor**

# Overview



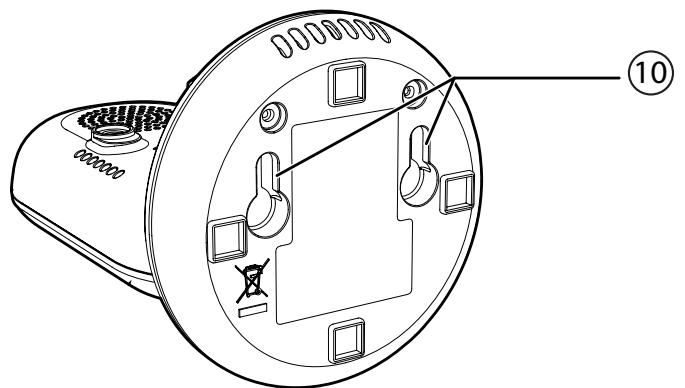
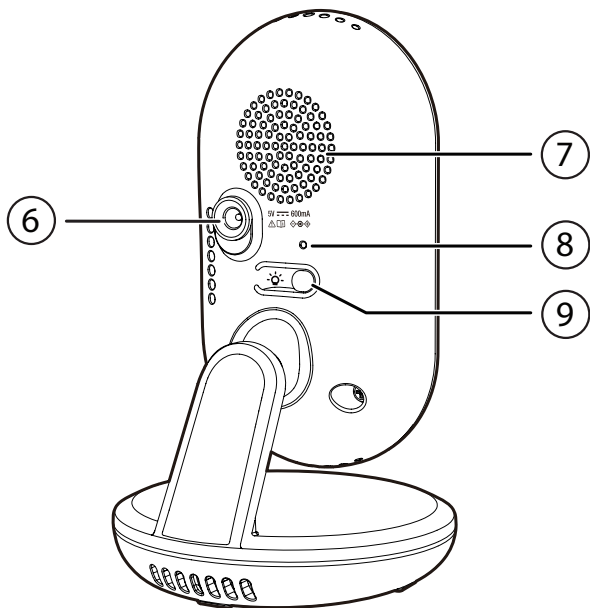
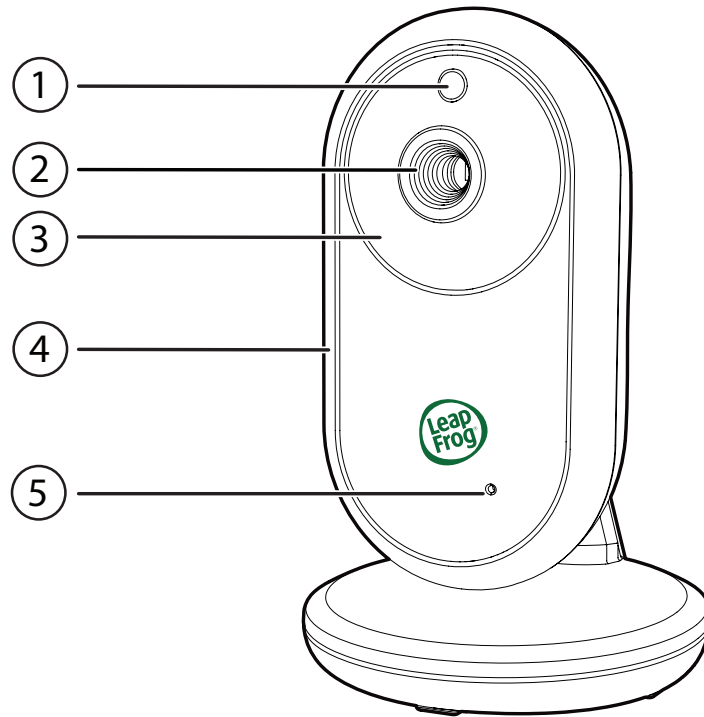





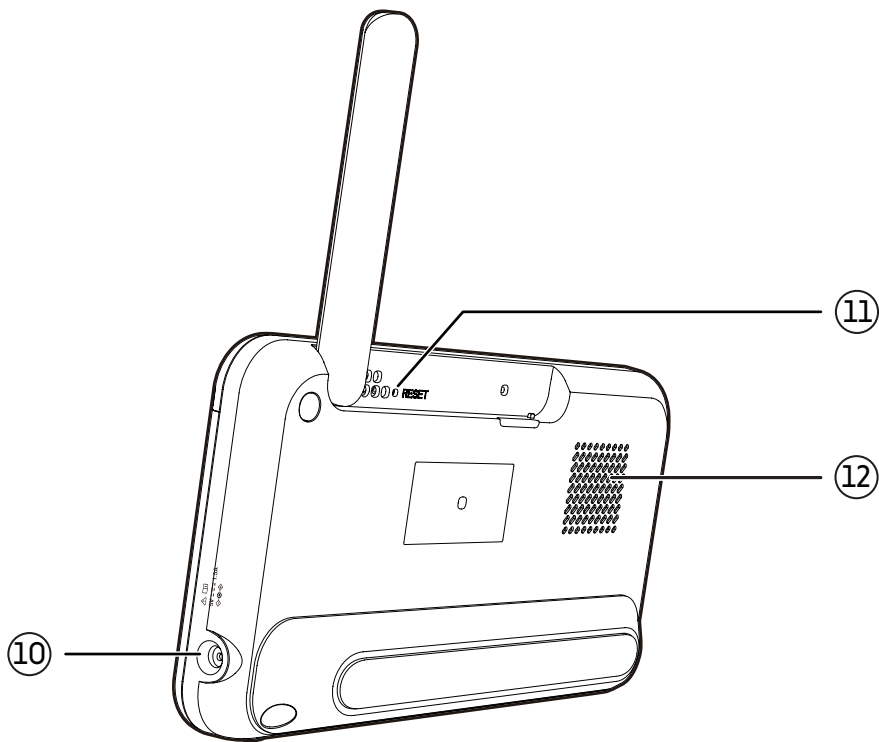
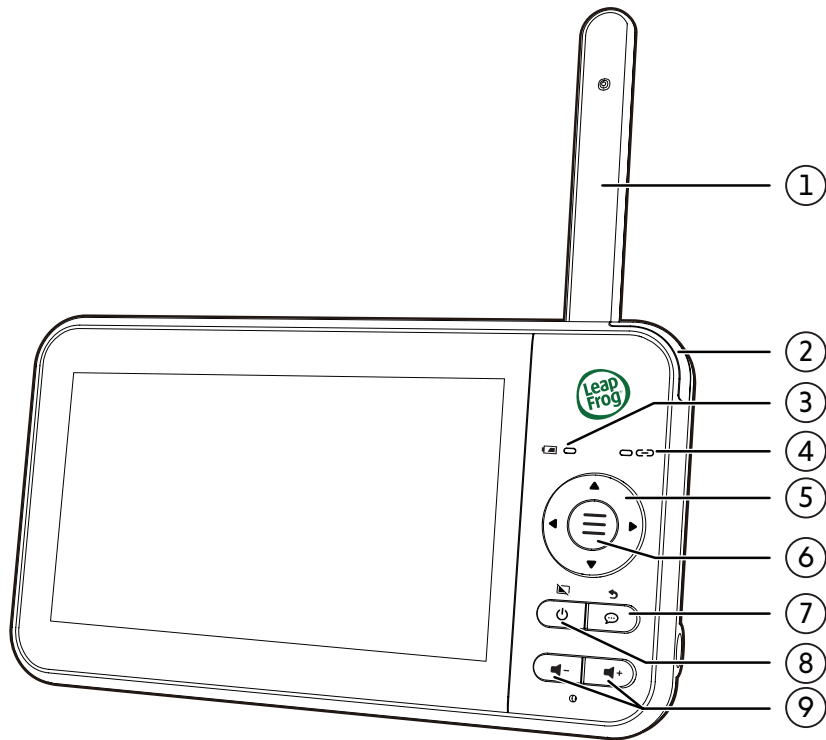

## Baby Unit



<b>1</b>	<b>Light Sensor</b>
<b>2</b>	<b>Camera lens</b>
<b>3</b>	<b>Infrared LEDs</b> <ul style="list-style-type: none"> <li>• Allow you to see clearly in a dark environment.</li> </ul>
<b>4</b>	<b>Night light</b>
<b>5</b>	<b>Microphone</b>
<b>6</b>	<b>Power jack</b>
<b>7</b>	<b>Speaker</b>
<b>8</b>	<b>PAIR key</b> <ul style="list-style-type: none"> <li>• The Parent Viewer and Baby Unit(s) provided are already paired</li> </ul>
<b>9</b>	 <b>Night light control key</b> <ul style="list-style-type: none"> <li>• Press to turn the night light on or off.</li> </ul>
<b>10</b>	<b>Slots for wall mounting</b>

















# Parent Viewer

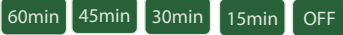

1	<b>Antenna</b>
2	<b>3-level sound indicator light</b>
3	 <b>Battery LED light</b> <ul style="list-style-type: none"> <li>• On when the Parent Viewer is connected to AC power, and the battery is charging.</li> <li>• Flashes when the Parent Viewer battery is low and needs to be charged.</li> </ul>
4	 <b>LINK LED light</b> <ul style="list-style-type: none"> <li>• On when the Parent Viewer is linked to the Baby Unit.</li> <li>• Flashes when the link to the Baby Unit is lost.</li> </ul>
5	<b>Arrow keys</b>  <ul style="list-style-type: none"> <li>• Navigate within the menus.</li> </ul>
6	 <b>MENU/SELECT</b> <ul style="list-style-type: none"> <li>• Press to enter the main menu.</li> <li>• While in a menu, press to choose an item, or save a setting.</li> </ul>
7	 /  <b>RETURN/TALK</b> <ul style="list-style-type: none"> <li>• Press and hold to talk to the Baby Unit.</li> <li>• While in a sub-menu, press to exit.</li> </ul>
8	 /  <b>LCD off/POWER key</b> <ul style="list-style-type: none"> <li>• Press and hold to power on/off the Parent Viewer.</li> <li>• Press to screen on/off.</li> </ul>
9	 - /  + ( <b>VOL -/VOL +</b> )
10	<b>Power jack</b>
11	<b>RESET</b> <ul style="list-style-type: none"> <li>• Force reboot the Parent Viewer</li> </ul>
12	<b>Speaker</b>

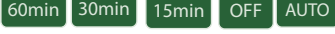

# Parent Viewer Icons

Main Menu	Sub-menu	Options
<b>Brightness</b>		
		Adjust the Parent Viewer LCD screen brightness.
<b>Lullaby</b>		
		Play/Stop
		Select to play one of the four soothing sounds.
		 Select to play one of the five melodies or play all.
		 Set a timer to stop the lullaby, or play non-stop.
<b>Night light</b>		
		Turn on/off night light.
		 Select from 7 night light colours or auto-colour change.
		 <b>Night light timer</b> <ul style="list-style-type: none"> <li>• Set a timer to turn off the night light or auto-on when sound detected.</li> <li>• If timer is set to <b>OFF</b>, and the night light is turned on, then the night light remains on always.</li> <li>• If this is set to <b>AUTO</b>, the night light will remain on for 15 minutes. If you manually switch off the night light, while <b>AUTO</b> is selected, the night light will turn on when the detected sound exceeds the selected Sound Sensitivity Level and last for 15 minutes.</li> </ul>
		<ul style="list-style-type: none"> <li>• Turn on/off auto adaptive night light.</li> </ul>

## Screen off Timer



OFF 5min 30min 60min

- Select a screen off time, or always remain on.

AUTO VOX level

- Set the Sound Sensitivity Level for auto screen on.

## Alert settings



- Turn on/off Low battery alert tone.



- Turn on/off Link lost alert tone.



- Turn on/off Confirmation alert tone.

## Temperature



Turn on/off temperature Alert.



Select the minimum and maximum temperature range.



Temperature display format.

## Camera settings





Adjust the Baby Unit's speaker volume.



Zoom

## Status icon

	Connection status
 	Current view status <ul style="list-style-type: none"><li>• The Baby Unit number that is being viewed.</li></ul>
	Night light is turned on.
	Auto-on night light is turned on.
	Zoom is turned on.
	Night vision is turned on.
	Melodies and soothing sounds are playing.
	Talkback is on.
	Sound level indicator
	Parent Viewer is muted.
	Temperature alert is turned on.
 	Temperature
	Battery indicator
	Low battery indicator

# Connect the Baby Monitor

Connect the Parent Viewer and Baby Unit to a power supply with the included power adaptors.

## Notes:

- Baby Unit turns on automatically after it connects to the power socket.
- The rechargeable battery in the Parent Viewer is built-in.
- Use only the power adaptors supplied with this product.
- Make sure the Parent Viewer and the Baby Unit are not connected to an electronically controlled electric outlet.
- Connect the power adaptors in a vertical or floor mount position only. The adaptor prongs are not designed to hold the weight of the Parent Viewer and the Baby Unit, so do not connect them to any ceiling, under-the-table, or cabinet outlets. Otherwise, the adaptors may not properly connect to the outlets.
- Make sure the Parent Viewer, the Baby Unit and the power adaptor cords are out of reach of children.

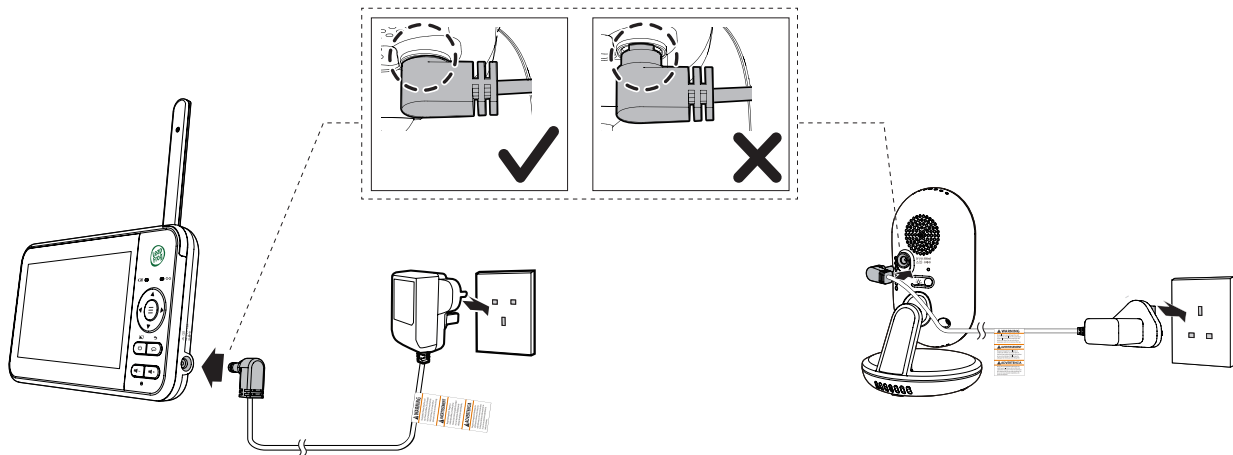

# Charge the Parent Viewer Battery



The Parent Viewer runs on an internal rechargeable battery or AC power. To continuously monitor your baby, keep the Parent Viewer connected to AC power.

The Parent Viewer turns on automatically after it connects to the power socket, and its battery will charge at the same time.

## Notes:

- Before using the baby monitor for the first time, charge the Parent Viewer battery for 12 hours. When the Parent Viewer battery is fully charged, the battery icon becomes solid .
- The standby time varies depending on your actual use.

The battery icon on the screen indicates the battery status (see the following table).



Battery Indicators	Battery Status	Action
The screen displays  . The  LED light flashes.	The battery power is very low and may only be used for a short time.	Charge without interruption (about 30 minutes).
The battery icon becomes solid  .	The battery is fully charged.	To keep the battery charged, connect it to AC power when in use.

# Power On or Off the Baby Monitor

1. Connect the power adaptor to the Baby Unit and a power supply to power on the unit.

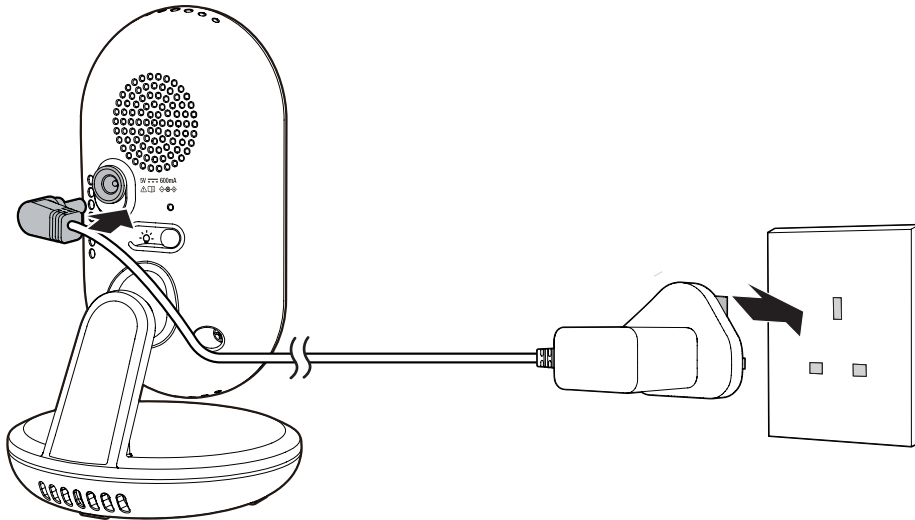
Disconnect from the power supply to power off.



2. Press and hold  to turn on the Parent Viewer, the welcome screen appears and the green  LINK LED flashes.

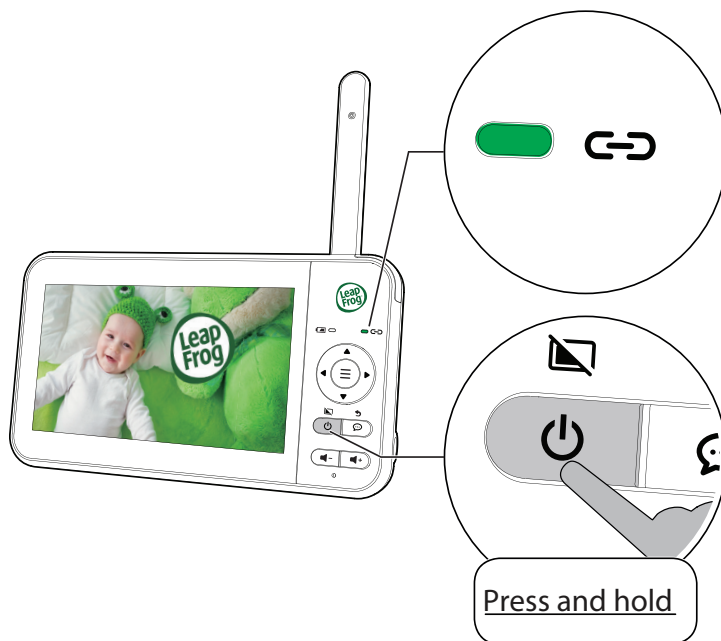

3. Once your Baby Unit and Parent Viewer are powered on, the Parent Viewer and Baby Unit will pair each other automatically. When they are connected successfully, the  LINK LED lights steadily. And your Parent Viewer streams live video from the Baby Unit.

# Positioning the Baby Monitor

**Caution:** Keep the Baby Unit out of the reach of your baby. Never place or mount the Baby Unit inside the baby's cot or playpen.

Place the Baby Unit more than 1m away from your baby.

1

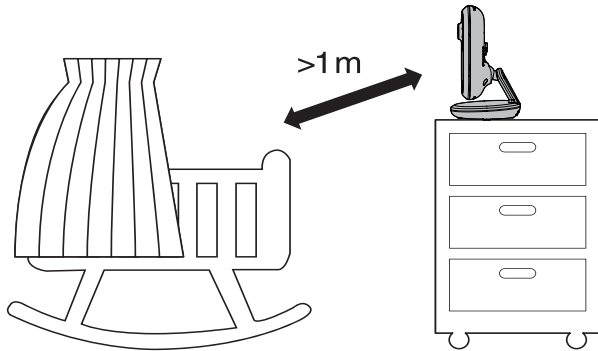

2

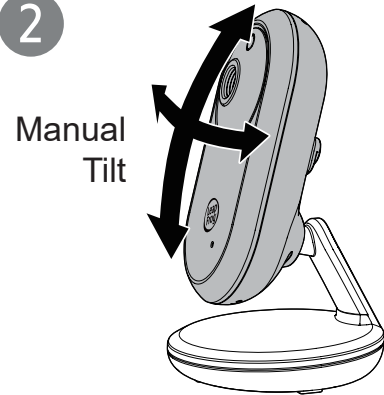

## Cautions:

- The default volume of your Parent Viewer is level 3, and the maximum volume is level 5. If you experience feedback noise from your baby monitor while positioning:
  - Make sure your Baby Unit and Parent Viewer are more than 1 metre apart; **OR**
  - Lower the volume of your Parent Viewer.



3

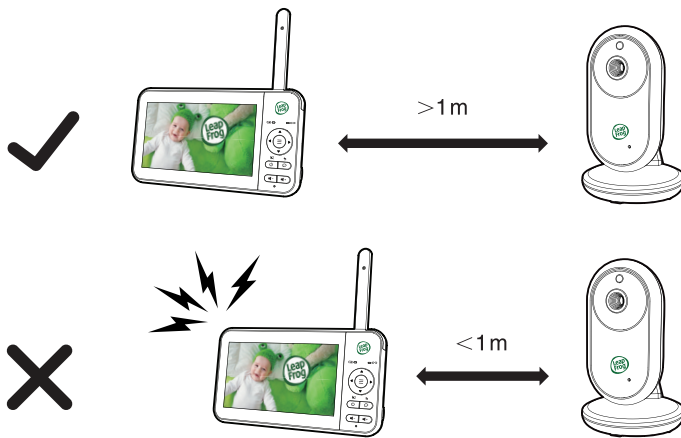

- To avoid interference from other electronic devices, place your baby monitor at least 1 metre away from devices such as wireless routers, microwaves, mobile phones and computers.

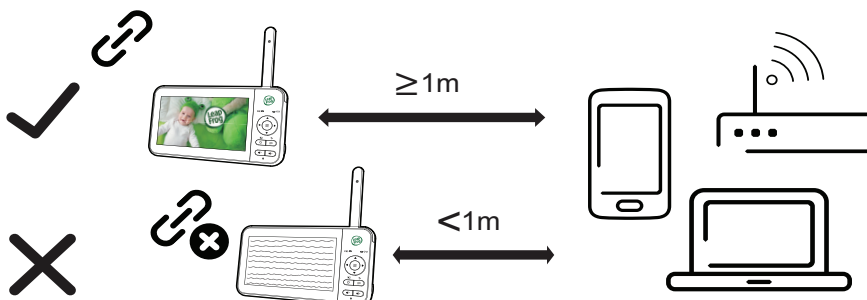

4





# Basic Operation

## Talk to Your Baby via the Baby Unit

You can use the  **Talk** function on the Parent Viewer to comfort your baby from the other room.

1. Press and hold the  key. The status icon  appears on the screen.
2. Speak towards the microphone on the Parent Viewer. Your voice is transmitted to the Baby Unit.
3. When finished talking, release the  key to hear your baby again.

### Notes:

- The Parent Viewer speaker is muted during voice broadcast. Sound transmission from the Baby Unit resumes after  is released.
- After around 20 seconds of sound re-transmission, the speaker returns to mute if you had set it to mute before pressing .

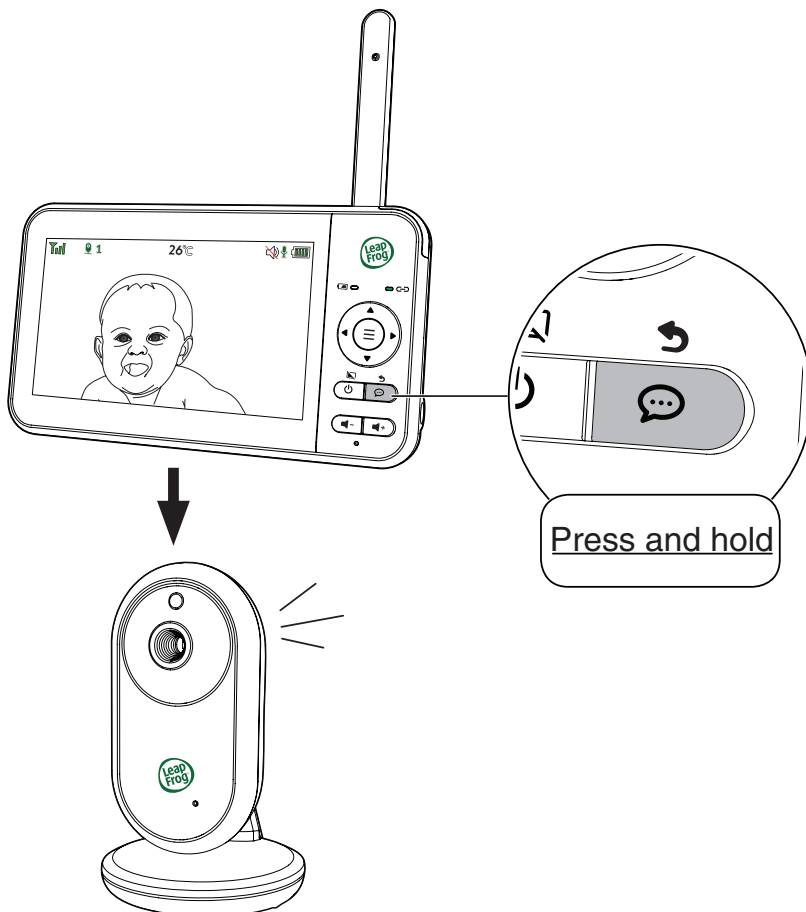



# Use the Menu



Press **≡** on the Parent Viewer to enter the main menu, choose a menu item, or save a setting. You can use the Parent Viewer menu for advanced settings or operations, such as to play or stop the Baby Unit lullaby, or to adjust the Baby Unit sound sensitivity.

While in the menu:

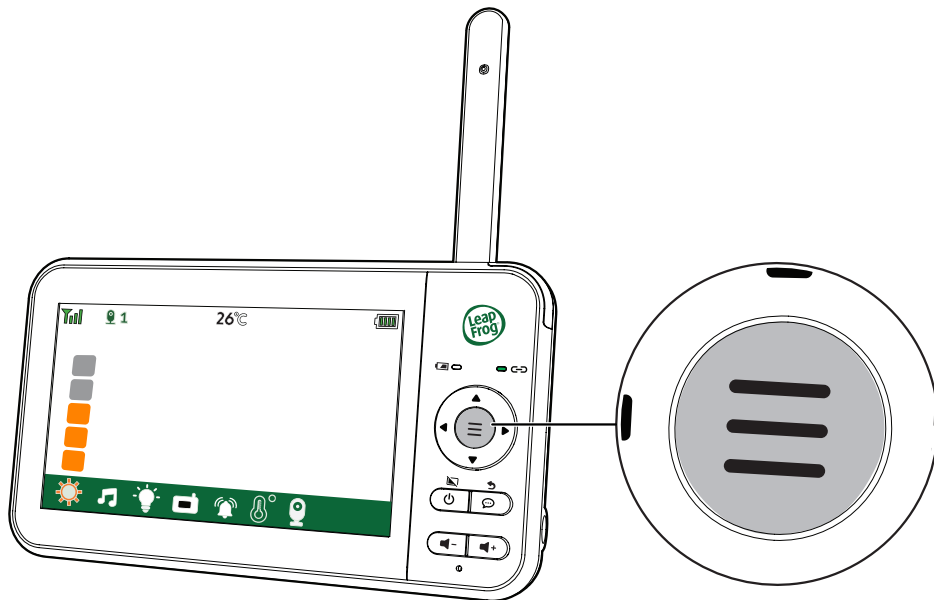
- Press ◀ or ▶ to scroll among the menu options.
- Press **≡** to select an item, or to save a setting.
- Press ▲ or ▼ to scroll among the sub-menus, or to adjust a setting.
- Press ◀ to return to the previous menu options without changing the current setting.
- Press ↶ / 💬 to return to the live video.







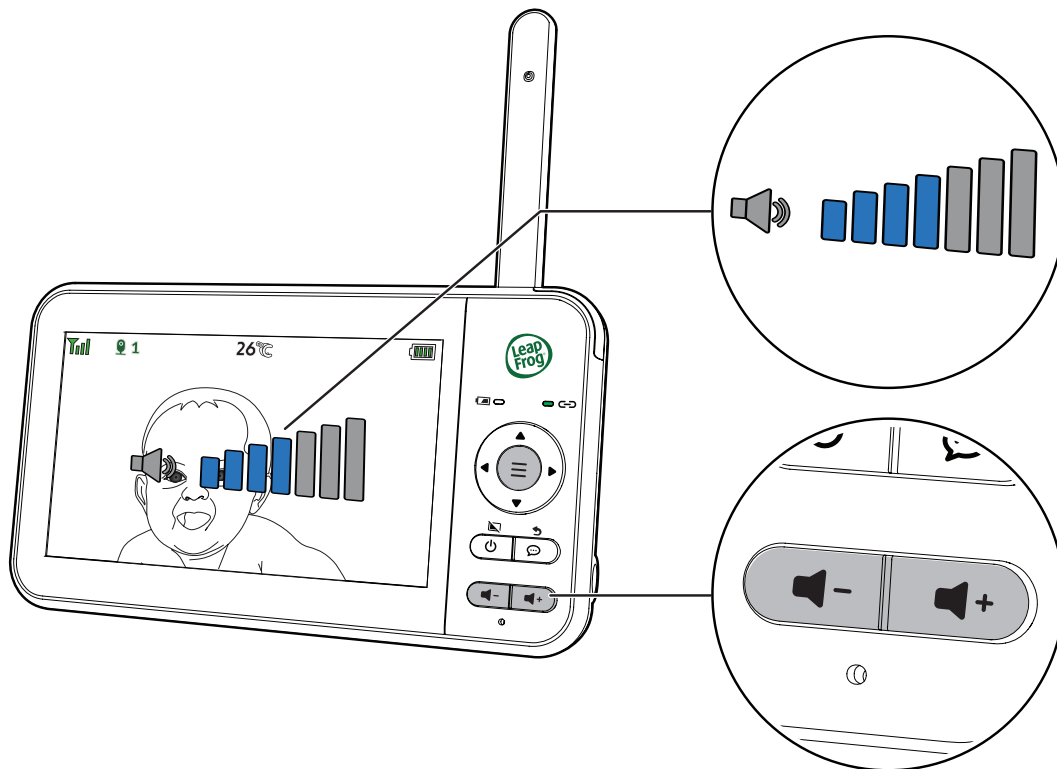





# Adjust Speaker Volume

Press  - |  + to adjust the speaker volume level on the Parent Viewer, received from the Baby Unit.



# Zoom



1. Press  to enter the main menu.
2. Press  or  to go to  (**Camera Settings**) menu , then press  to confirm.
3. Press  or  to select  (**zoom**).
4. Press  or  to select and press  to confirm.

You can zoom in or out your image between **1x** and **2x**.



# Turn on/off the Parent Viewer Screen

You can turn on or turn off the Parent Viewer screen without powering off the unit. When the screen is turned off, you can still hear from the Baby Unit.



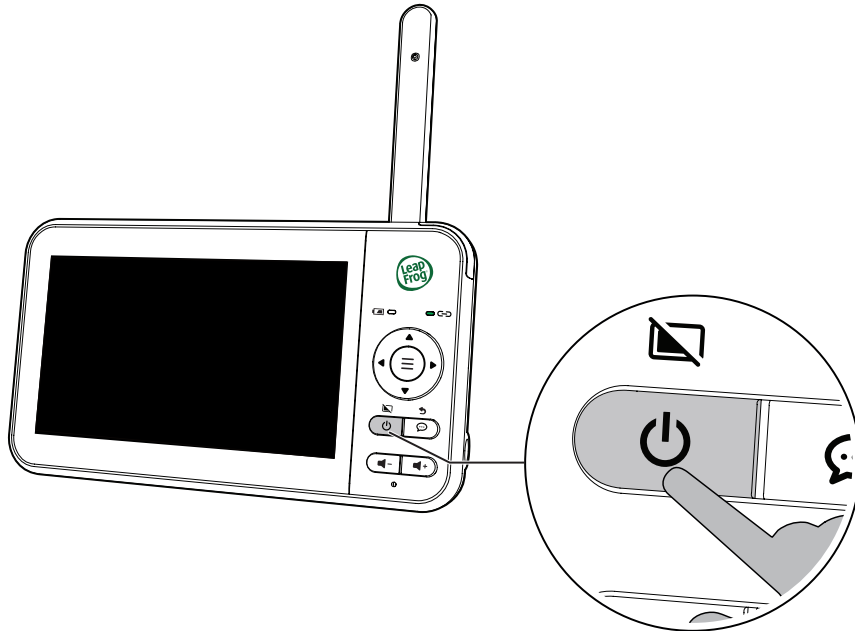



- Press  /  on the Parent Viewer to turn off the screen.
- Press any key on the Parent Viewer to turn the screen on again.



# Adjust Screen Brightness

You can change the brightness of the Parent Viewer screen from Level 1 to Level 5. The LCD screen brightness is preset to Level 3.

**To adjust LCD brightness:**

1. Press  to enter the main menu, press  again to select  (**Brightness**) when the Parent Viewer is idle.
2. Press  to increase or press  to decrease the brightness, then press  to confirm your setting.

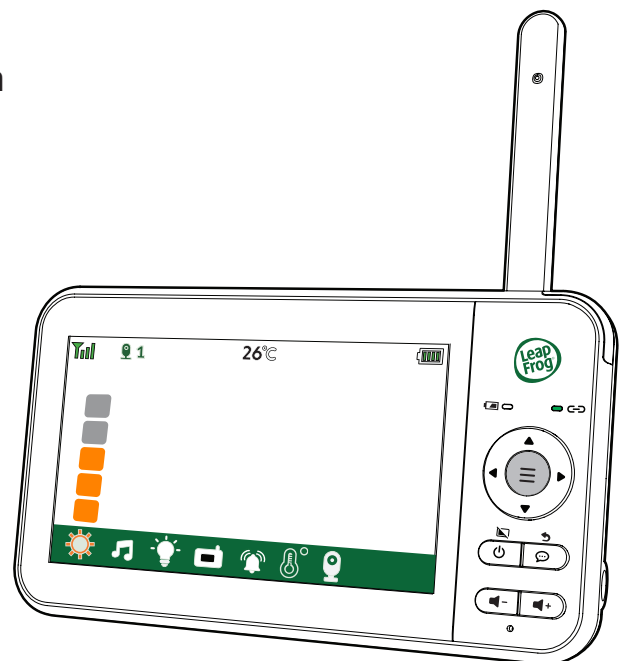





# Advanced Operation

## Lullabies and Soothing Sounds

There are 5 lullabies and 4 soothing sounds in the baby monitor for you to comfort your baby with.

### Play the Lullabies and Soothing Sounds













1. Press  to enter the main menu.
2. Press  or  to highlight  (Lullaby).
3. Press  to toggle between  (Play) and  (Stop).
4. To select a lullaby or soothing sound, press  or  to highlight  (Lullabies) or  (Soothing Sound), then press .
5. For soothing sounds, press  or  to highlight a sound  1  2  3  4, then press , or you can select a lullaby or play all five lullabies.
6. For playing lullabies, press  or  to highlight  1  2  3  4  5 or you can select  to play all lullabies repeatedly. Press  to confirm your selection.
7. You can also set the timer to stop playing the selected melodies or soothing sound. Press  or  to highlight  (Timer), and then press . Then, press  or  to highlight  60min  45min  30min  15min  OFF, then press  to confirm your setting.

#### Note:

- The lullaby playback on the Baby Unit will be paused when receiving talkback from the Parent Viewer.

## Adjust Baby Unit Speaker Volume

To adjust the lullaby playing and talkback volume level transmitted from the Parent Viewer:

1. Press  to enter the main menu.
2. Press  or  to go to  (Camera Settings) menu, then press  to confirm.
3. Press  or  to select  (Camera Speaker Volume), then press .
4. Press  to increase or press  to decrease the Volume, and press  to confirm.





# Night Light

You can control the night light remotely on the Parent Viewer or directly on the Baby Unit.



## On the Baby Unit

Slide the **Night Light Control Key**  located at the back of the Baby Unit to turn on/off the night light.









## On the Parent Viewer

1. Press  to enter the main menu when the Parent Viewer is idle.
2. Press  or  to go to  (**Night Light**) menu.













### To turn on/off the night light:

- Press  to toggle between  or .





### To change the night light colour:

- Press  or  to scroll to  (**Night Light Colour**), press . Then, press  or  to select one of the seven colours, or you can select  to change to all seven colours in cycle. Press  to confirm your selection.

### To set the night light timer:

- Press  or  to scroll to  (**Timer**), press . Then, press  or  to set timer    to turn the night light off. Or select  to keep the night light on, and press  to confirm your setting.
- Set timer to  to turn on the night light when Baby Unit detects sound. It will turn off after 15 minutes of no sound detection. You can set **Sound sensitivity level** to detect sound that exceeds setting level. See **Adjust Sound Sensitivity Level on page 24**.

















### To turn on/off the Adaptive night light:

- Press  or  to scroll to , press . Turn on/off the **Adaptive night light** feature. When this feature is on, the Baby Unit detects the Adaptive night light. If the room is bright, the night light adjusts itself to be brighter; if the room is dim, the night light adjusts itself to be dimmer.

# Set Screen off Timer

You can set a specific time interval, if no keys have been pressed on the Parent Viewer, the screen will turn off (goes to sleep) to save power. You can still hear sounds from the Baby Unit when the screen turns off.

If you select **Auto**, the Parent Viewer screen stays off when the Baby Unit detects no sound. Once the Baby Unit detects sounds that are louder than the selected **Sound Sensitivity Level**, the Parent Viewer screen turn on automatically. The Parent Viewer will then turn off again after no sound has been detected for a while.

1. Press  to enter the main menu.
2. Press  or  to go to  (**Screen off timer**), then press .
3. Press  or  to select a screen off time   , or select  to always remain on, then press  to confirm.
4. If you select , press , then press  or  to adjust the **Sound Sensitivity Level**. Press  to confirm.

## Note:

- If you have muted the Parent Viewer speaker, only the Parent Viewer screen will turn on when a sound is detected.

# Adjust Sound Sensitivity Level

You can choose to hear sounds from the Baby Unit continuously, or to only hear sounds that exceed a set sensitivity level.





When the Baby Unit detects sounds that exceed the set sensitivity level, the Parent Viewer screen turns on if it has been switched off, and the Baby Unit transmits the detected sounds to the Parent Viewer. You will immediately be able to see and hear your baby.

The night light will also turn on if you set the **Night Light Timer** to **Auto**.

Adjust the microphone sensitivity of your Baby Unit, the higher the sensitivity level, the more sensitive the Baby Unit is in detecting sounds to be transmitted to the Parent Viewer.

To adjust sound sensitivity level:

1. Follow the steps in **Adjust Screen off Timer** to set the **Screen off timer** to **AUTO**.
2. Press ▲ or ▼ to increase or decrease the sensitivity level.

Sound Sensitivity Level	Level 5 (Highest) 	Level 4 (High) 	Level 3 (Medium) 	Level 2 (Low) 	Level 1 (Lowest) 
Description	(Default setting) The Parent Viewer screen turns on for quiet sounds, (including background noises) from your baby's room.	The Parent Viewer screen turns on for soft babbling and louder sounds from your baby. The Parent Viewer remains quiet when your baby sleeps soundly.	The Parent Viewer screen turns on for loud babbling and louder sounds from your baby. The Parent Viewer remains quiet when your baby makes soft sounds.	The Parent Viewer screen turns on for crying and louder sounds from your baby. The Parent Viewer remains quiet when your baby makes soft sounds.	The Parent Viewer screen turns on for loud crying or screeching sounds from your baby. The Parent Viewer remains quiet when your baby makes soft sounds.















# Turn on/off Alert Tones

## Low Battery Alert Tone

You can set the Parent Viewer to beep when the Parent Viewer operates in low battery condition.

Switch it off if you do not wish to be disturbed when the Parent Viewer's battery is running low.













### To turn on or off low battery alert:

1. Press  on the Parent Viewer.
2. Press  or  to go to  (**Alert settings**), then press .
3. Press  or  to highlight  (**Low battery alert**), then press .
4. Press  to toggle between  and .

## No Link Alert Tone

You can set the Parent Viewer to beep when the link between the Parent Viewer and the Baby Unit is lost. If you are using only one Baby Unit with a Parent Viewer, but paired with two Baby Units, the No Link Alert Tone will activate until you have both paired Baby Units linked to the Parent Viewer. To continue using one Baby Unit, switch off the No Link Alert Tone so you won't be disturbed.













### To turn on or off lost link alert:

1. Press  on the Parent Viewer.
2. Press  or  to go to  (**Alert settings**), then press .
3. Press  or  to highlight  (**Lost link alert**), then press .
4. Press  to toggle between  and .

## Confirmation Tone

When you turn on Confirmation Tone alert, the Parent Viewer plays a confirmation tone whenever a setting is saved or item is selected.

### Turn on or off confirmation tone alert:

1. Press  on the Parent Viewer.
2. Press  or  to go to  (**Alert settings**), then press .
3. Press  or  to highlight  (**Confirmation tone**), then press .
4. Press  to toggle between  and .













# Temperature

## Temperature Alert

Your Baby Unit can help you keep track of your baby's room temperature in order to ensure that your baby stays in the comfort zone at all times.













With temperature sensor, the relevant data will be shown on the status bar when you powered on your units. If the detected temperature is out of the preset temperature range, the Parent Viewer beeps.

### *Turn on/off the Temperature Alert*

1. Press  when the Parent Viewer is idle.
2. Press  or  to go to  (Temperature).
3. Press  or  to select  (Temperature alert), then press .
4. Press  or  to select  or  , then press  to turn on or off temperature alert.











## Set the Temperature Range

You can set the desired room temperature alert range. The minimum temperature can be set between **10°C** and **24°C**. The maximum temperature can be set between **25°C** and **39°C**.

1. Press  when the Parent Viewer is idle.
2. Press  or  to go to  (Temperature).
3. Press  or  to select  (Maximum Temperature) or  (Minimum Temperature), press .
5. Press  or  to set the maximum or minimum temperature, and then press  to confirm.

## Set Temperature Format

You can choose to display the temperature in Fahrenheit (°F) or Celsius (°C)

1. Press  when the Parent Viewer is idle.
2. Press  or  to go to  (Temperature).
3. Press  or  to select  , then press .
4. Press  or  to select °C or °F, press  to confirm.

# Night Vision

The Baby Unit has infrared LEDs that allow you to see your baby clearly at night or in a dark room. When the Baby Unit being viewed detects low light levels, the infrared LEDs are switched on automatically. The images from the Baby Unit are in black and white, and 🌙 appears on the screen.

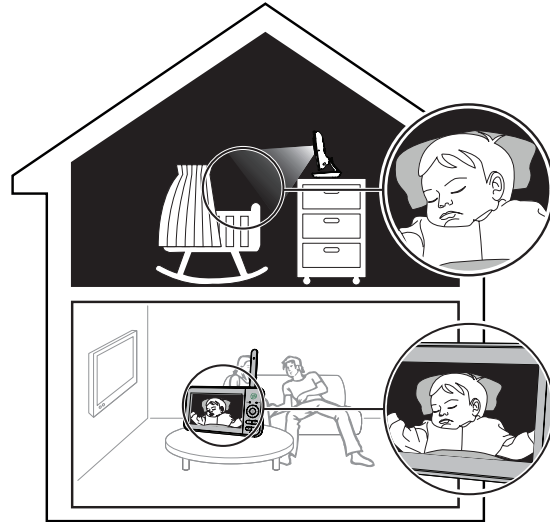

## Notes:

- It is normal to see a short white glare on your Parent Viewer screen as the Baby Unit adapts to the dark environment.
- When the infrared LEDs are on, the images are in black and white. This is normal.

**Tip:** Depending on the surroundings and other interfering factors, for example, lighting, objects, colours and backgrounds, the image quality may vary. Adjust the Baby Unit angle or place the Baby Unit at a higher location to prevent glare and a blurred display.

# Dim Mode

Dim Mode automatically activates to help you save Parent Viewer power and cannot be turned off.

When your Parent Viewer is not charging, the display will automatically dim after 10 minutes of inactivity if no keys are pressed or alerts are received from the baby unit.

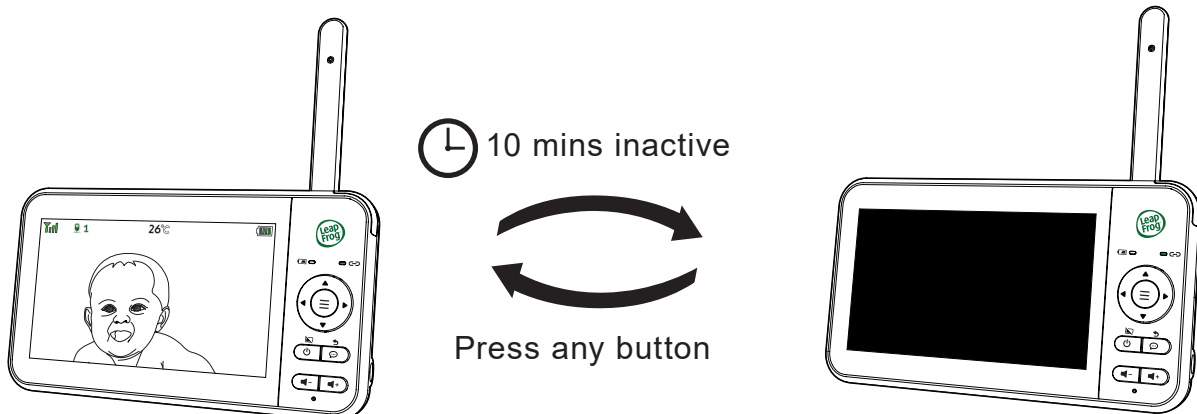

# Additional Information

## Wall Mount (Optional)

### Items to purchase

You will need to purchase the following items separately to mount your Baby Unit:



2 screws



2 wall plugs

### Notes:

- Check for reception strength and camera angle of the Baby Unit before drilling the holes.
- The types of screws and anchors you need depend on the composition of the wall.

1. Use a pencil to mark two holes in parallel. Make sure they are the same distance apart as the wall mount holes on the Baby Unit.

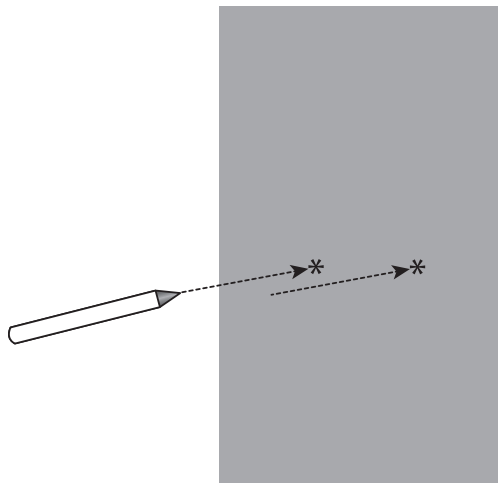

2. Drill two holes in the wall (5.5 mm drill bit). If you drill the holes into a stud, go to step 3.

### -OR-

If you drill the holes into an object other than a stud, insert the wall plugs into the holes. Tap gently on the ends with a hammer until the wall plugs are flush with the wall.

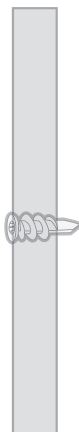

**3.** Insert the screws into the holes and tighten the screws until only 6.5 mm of the screws are exposed.

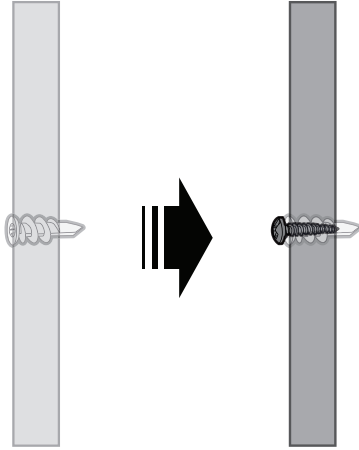

**4.** Align the wall mount holes on the Baby Unit with the screws on the wall. Slide the Baby Unit down until it locks into place.

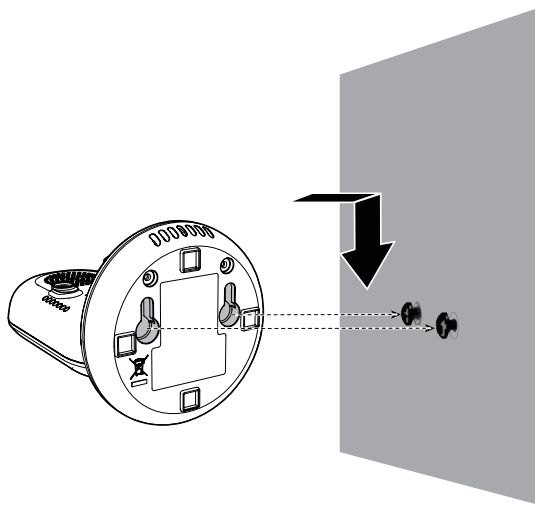

**5.** Adjust the camera angle.

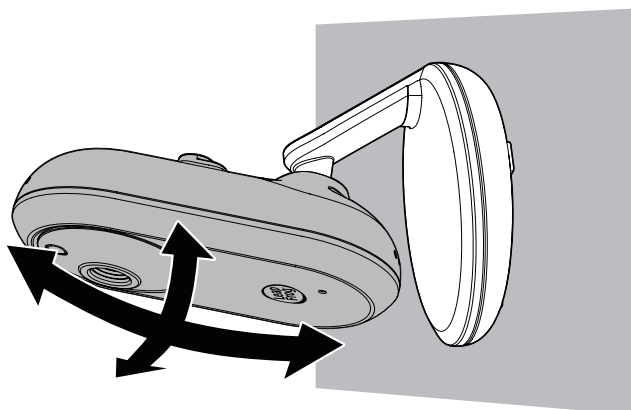

# General Product Care

To keep this product working well and looking good, follow these guidelines:

- Avoid placing it near heating appliances and devices that generate electrical noise (for example, motors or fluorescent lamps).
- DO NOT expose it to direct sunlight or moisture.
- Avoid dropping the product or treating it roughly.
- Clean with a soft damp cloth.
- DO NOT immerse the Parent Viewer and the Baby Unit in water and do not clean them under running water.
- DO NOT use cleaning spray or liquid cleaners.
- Make sure the Parent Viewer and the Baby Unit are dry before you connect them to the mains again.

## Storage

When you are not going to use the baby monitor for some time, store the Parent Viewer, the Baby Unit and the adaptors in a cool, dry place.

## Adult Supervision

- This baby monitor should be used as an aid and proper adult supervision is required.
- Do not place the Baby Unit inside the crib or playpen.
- As for children's safety, touch or play with the baby monitor and all the accessories are not allowed. THIS IS NOT A TOY.

## Technical Specifications

Frequency Control	Crystal controlled PLL synthesizer
Channels	32
Frequency	Baby Unit: 2405 - 2475 MHz Parent Viewer: 2405 - 2475 MHz
LCD	5" Colour LCD (WQVGA 480x272 pixel)
Power requirements	Parent Viewer: 3.6V, 2600mAh Li-ion, 9.36Wh Li-ion battery Baby Unit power adaptor: Output: 5V DC @ 600mA Parent Viewer power adaptor: Output: 5V DC @ 1A
Maximum power used by the transmitter	0.1 W (100 mW)

# Disposal of Batteries and Product



The crossed-out wheelie bin symbols on products and batteries, or on their respective packaging, indicates they must not be disposed of in domestic waste as they contain substances that can be damaging to the environment and human health.



The chemical symbols Hg, Cd or Pb, where marked, indicate that the battery contains more than the specified value of mercury (Hg), cadmium (Cd) or lead (Pn) set out in Battery Directive (2006/66/EC).

The solid bar indicates that the product was placed on the market after 13th August, 2005.

Help protect the environment by disposing of your product or batteries responsibly.

# Customer service and product warranty



## PRODUCT WARRANTY

Thank you for choosing this quality product from VTech.

1. The product detailed above is covered by a one year warranty from the date of purchase, against any defects in materials or workmanship.
2. The product may be returned to the place of purchase.
3. If the product covered by this warranty is damaged due to misuse, modification or unauthorized repair, or because of faulty batteries, battery discharge or incorrect electrical connections, then this warranty becomes void.
4. This warranty is personal to the original purchaser and is not transferable.
5. Breakages to the LCD screen are not covered by the warranty.

Email: [service-ukbm@vtechphones.eu](mailto:service-ukbm@vtechphones.eu)

VTech Electronics Europe Plc, c/o XPO Logistics, Warehouse 350, Cat & Fiddle Lane, West Hallam, DE7 6HE

THIS WARRANTY IS OFFERED AS AN EXTRA BENEFIT AND DOES NOT AFFECT CONSUMERS' STATUTORY RIGHTS.

This warranty is valid for the UK and Ireland only. For products purchased outside the UK and Ireland, please contact your local distributor or place of purchase.

## IMPORTANT

Please retain your sales receipt as proof of the date of purchase.

## Customer Support

Find the answer to your questions. Get assisted at your own pace using our knowledge-rich full Online Manual.

Scan the QR code to access the website or visit [leapfrog.com/en-gb/support](http://leapfrog.com/en-gb/support).



# Declaration of Conformity

This product is intended for use within Europe and UK.

This equipment complies with the essential requirements to EU's Radio Equipment Directive (2014/53/EU) and the UK's Radio Regulations 2017 on radio systems and telecommunication equipment.

LeapFrog Enterprises, Inc., a subsidiary of VTech Holdings Limited hereby declares that LF2415 is in compliance with the essential requirements and other relevant provisions of EU's Radio Equipment Directive (2014/53/EU) and UK's Radio Equipment Regulations 2017.

The Declaration of Conformity for the LF2415 is available from [leapfrog.com/en-gb/legal/eudoc](http://leapfrog.com/en-gb/legal/eudoc).



Manufacturer: VTech Telecommunications Ltd.

23/F., Tai Ping Industrial Centre, Block 1, 57 Ting kok Road, Tai Po, Hong Kong.

Importer: VTech Electronics Europe Plc

Napier Court, Abingdon Science Park, Abingdon, Oxon, OX14 3YT, U.K.