

Malmo

Cot Bed with Cot Top Changer

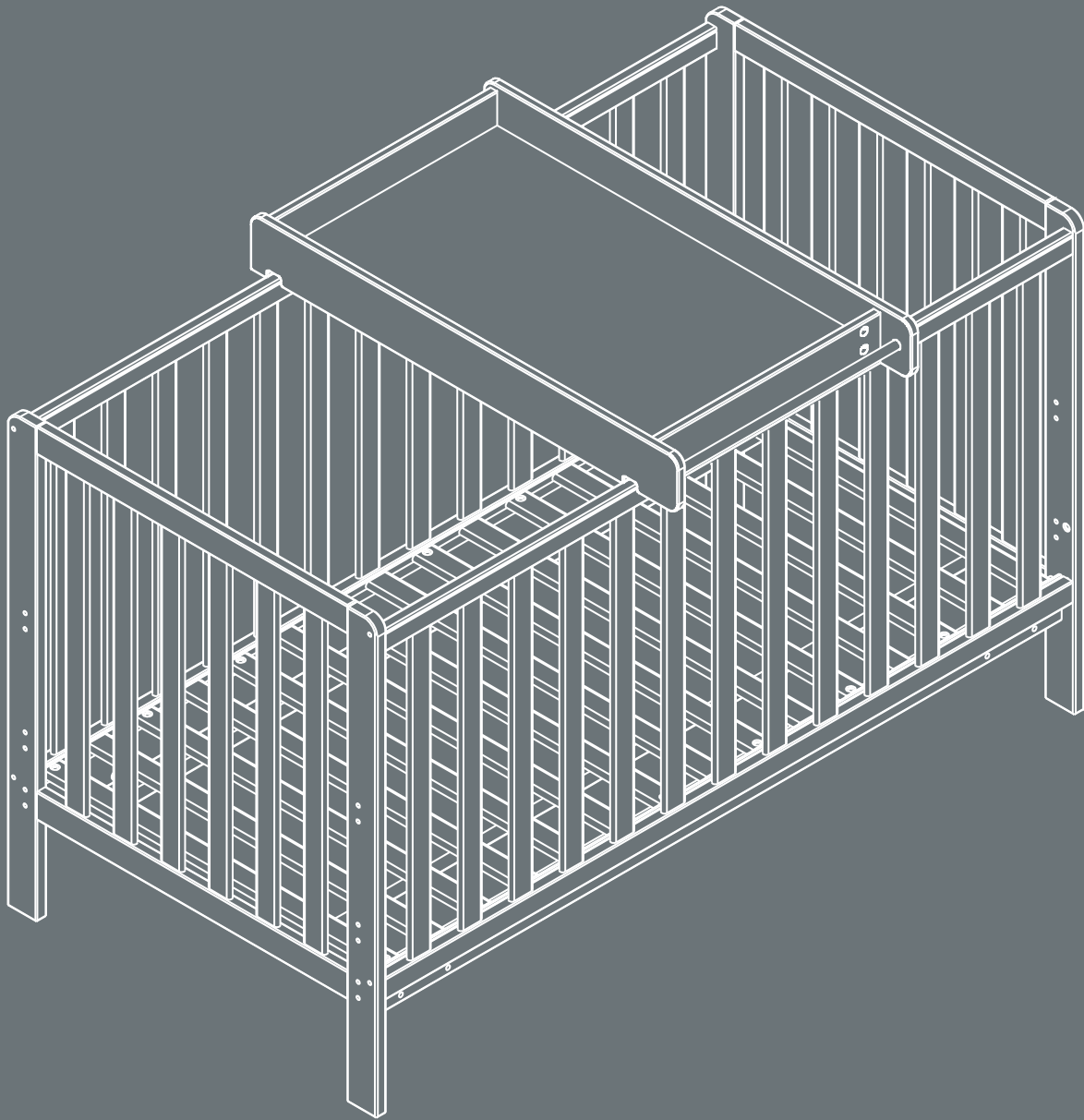

Assembly Instructions

Conforms to BS EN 716:2017+AC:2019 and BS 8509:2008+A1:2011
and EN 12221:2008+A1:2013

Tutti Frutti Direct Ltd. 1068 High Road, London, N20 0QP

t: + 44 (0) 208 368 5800

e: support@tuttibambini.com

www.tuttibambini.com

Malom

Cot Bed

with Cot Top Changer

211032

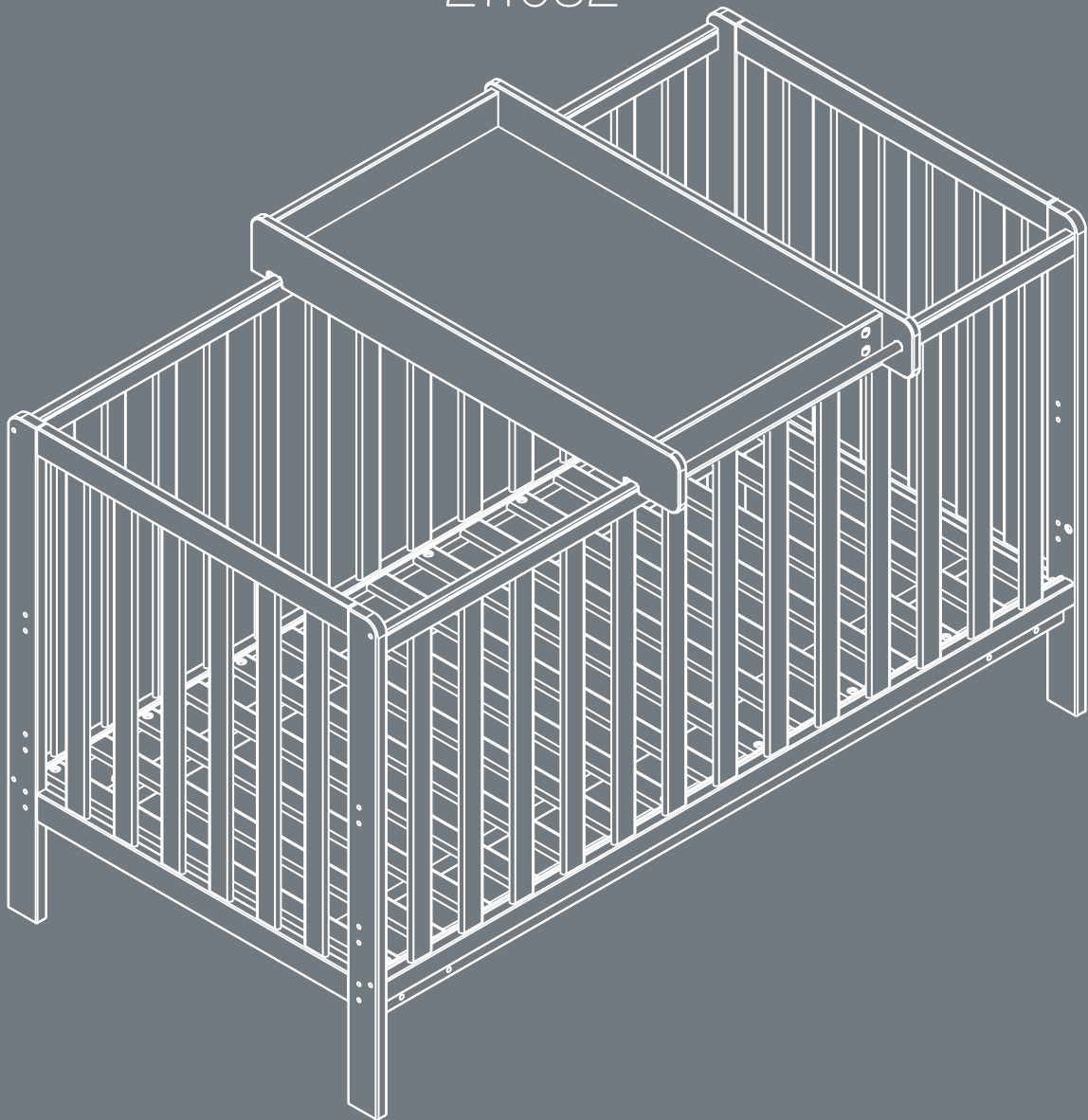

IMPORTANT: RETAIN FOR FUTURE REFERENCE.
READ CAREFULLY

Hello,

PLEASE READ THIS LEAFLET BEFORE ASSEMBLY

Dear Customer,

Thank you for buying Tutti Bambini furniture. Follow the instructions carefully and check that you have all the elements including the fittings before attempting assembly. If there are any missing or damaged parts, please inform us before you start the assembly. **WARNING:** installation shall be carried out exactly according to the manufacturer's instructions otherwise a safety risk can occur if incorrectly installed. Please note that incorrect assembly of your furniture will not be a basis for a claim against the product being damaged.

In the unlikely event that your furniture is found to be faulty, we ask that you send an email to: support@tuttibambini.com with the following information that can be found on the white label on the outside parcel.

- Name
- Postcode
- Contact telephone number
- Sales order number (found on white label)
 - Product name & colour
 - Damaged part number
- A photo or video of the damaged part





Tutti Bambini guarantee your product against faulty manufacture for a period of 12 months from date of receipt of purchase. This does not affect your statutory rights

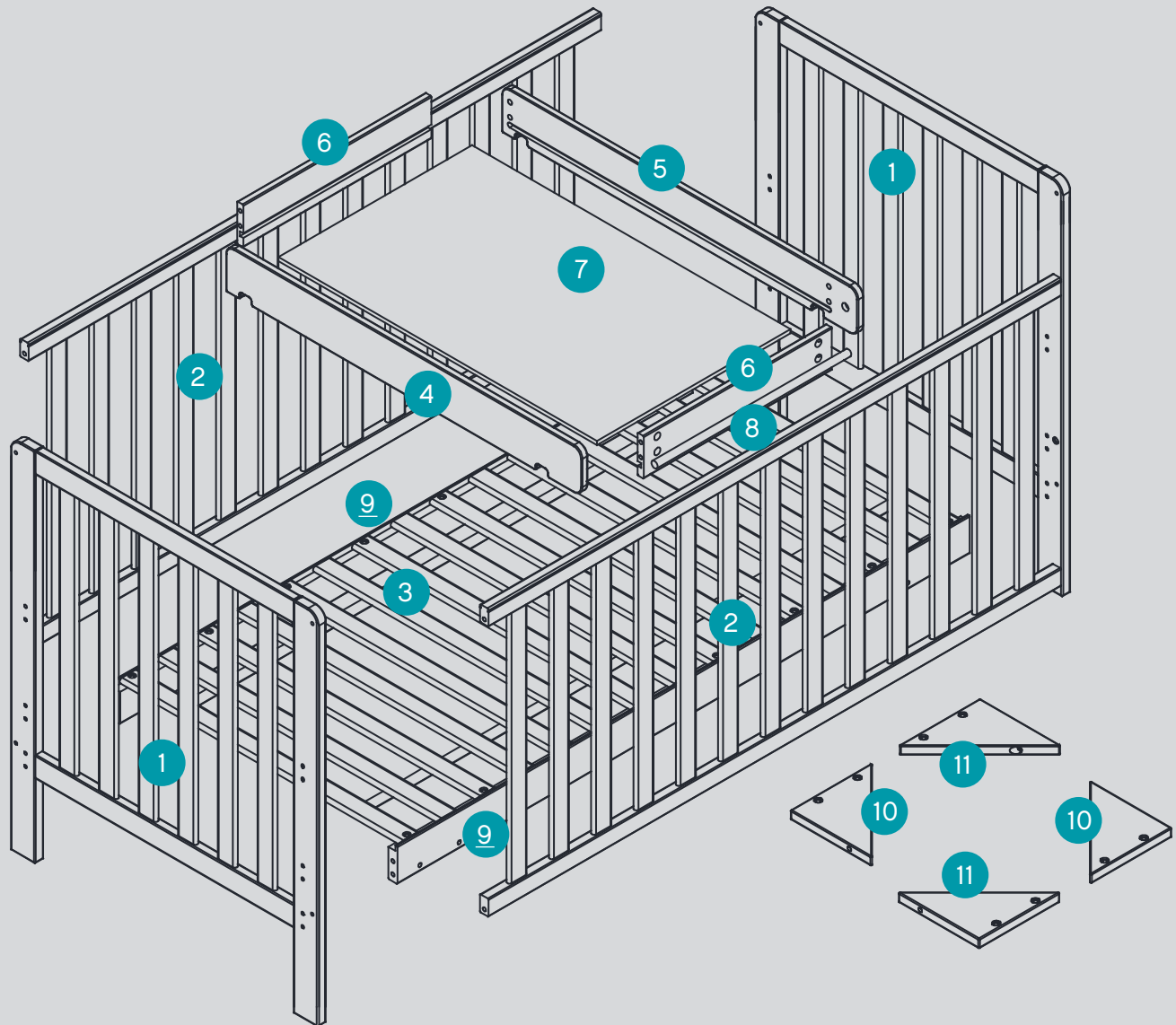



Team Tutti

Parts List



Hardware List

ID#			Qty
A		Pin	8 pcs
ID#			Qty
B		Cam	8 pcs
ID#			Qty
C	M6x60mm	Bolts	16 pcs
ID#			Qty
D		Allen Key	1 pcs
ID#			Qty
E			1 pcs

ID#			Qty
F	M6x20mm	Bolts	16 pcs
ID#			Qty
G		Long Nut	4 pcs
ID#			Qty
H		Nut	8 pcs
ID#			Qty
I	M6x30mm	Bolts	8 pcs

Assembling into cot



Important note: First tighten all bolts by hand only, do not tighten all bolts with Allen Key until all parts have been fully assembled.

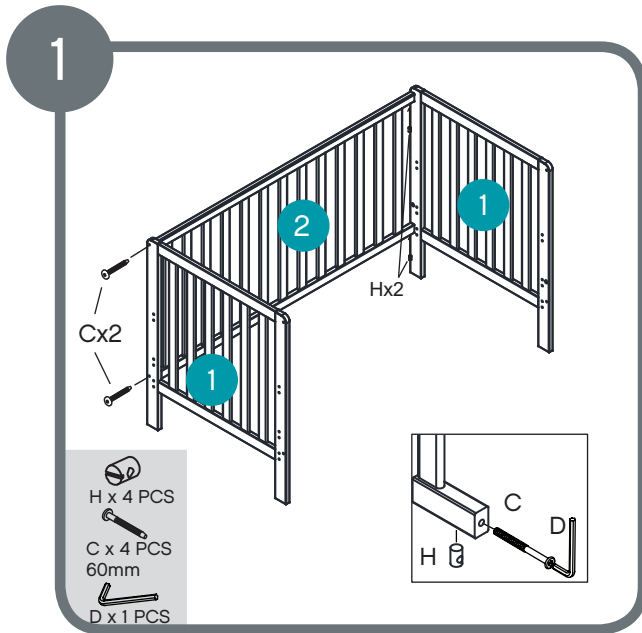

Assemble the 2 ends with fixed rail using 4 x C bolts

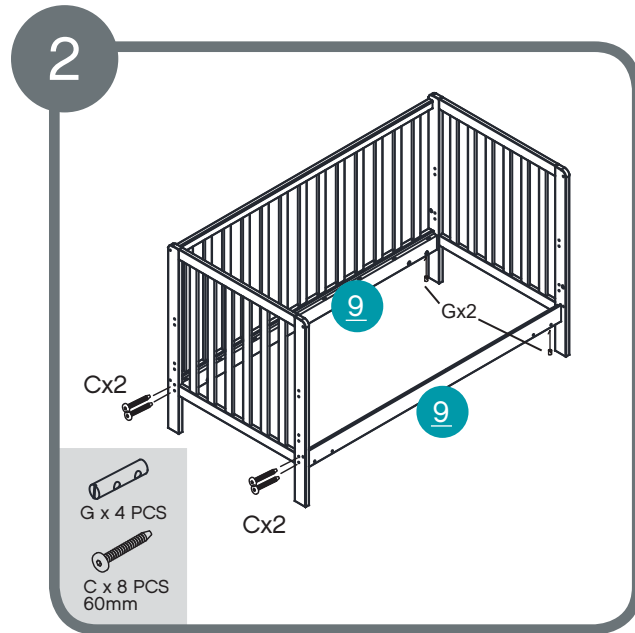

Assemble mattress support bar using 8 x C bolts

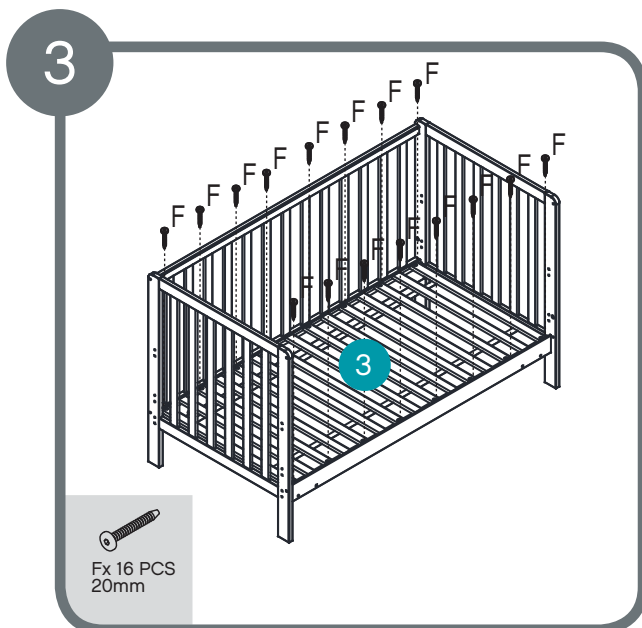

Assemble mattress base using 16 x F bolts

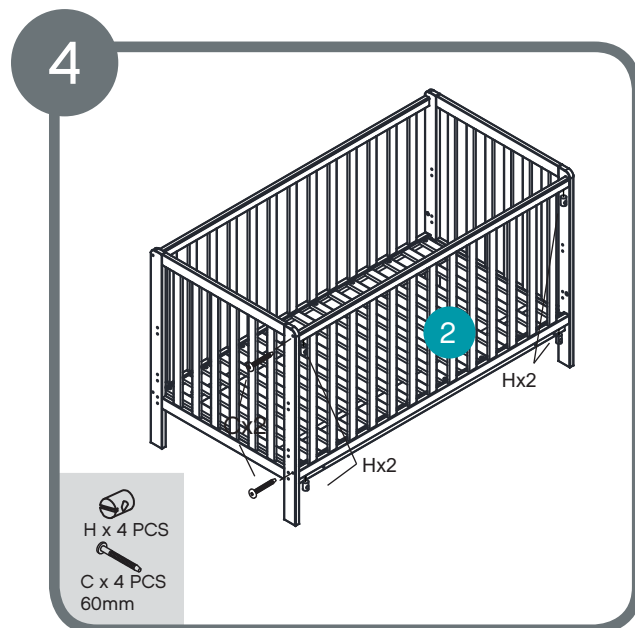

Assemble the 2 ends with fixed rail using 4 x C bolts

Assembling cot top changer

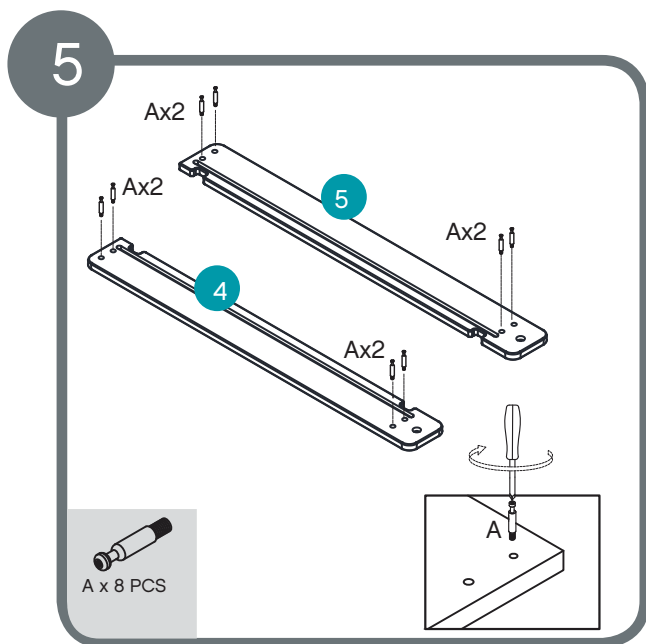

Assemble bolts

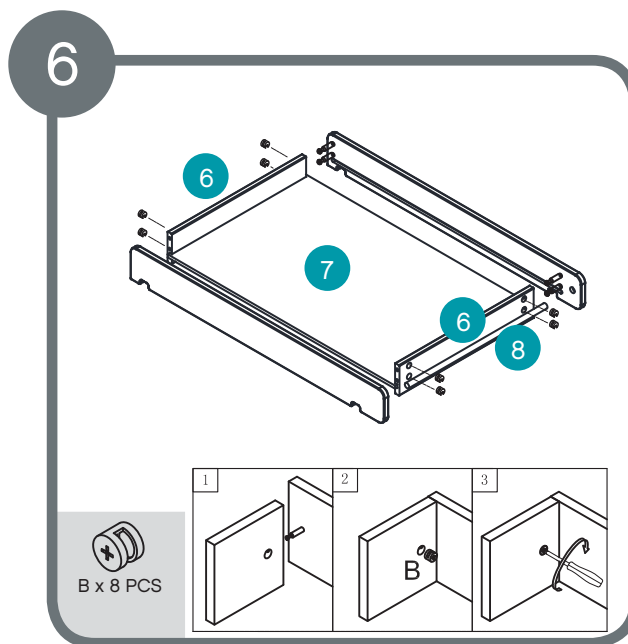

Assemble nuts

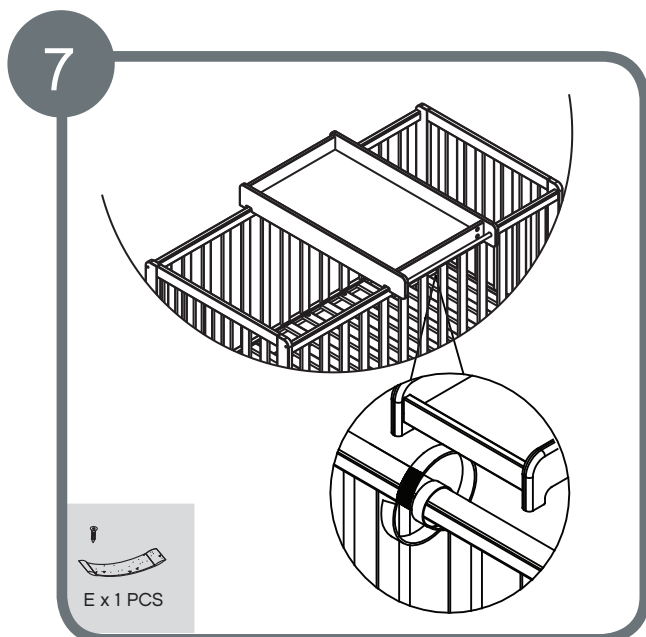

Place the changer onto the top side rails of the cot - the side rails should fit comfortably into the cut-outs on the changer.

Tightly fasten the Velcro strap attached to the changer around the cot sides top rail 1-2 loops (see diagram)

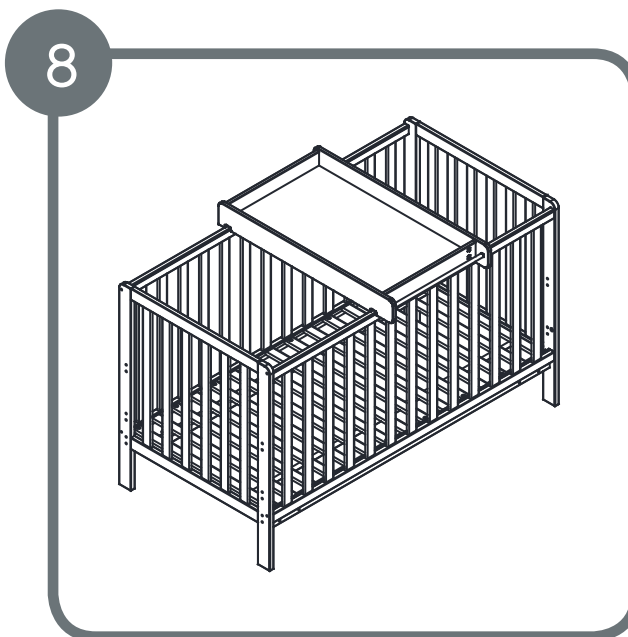

The changer is now ready for use.

IMPORTANT NOTE: The bottom mattress base position is the safest. You should always use the cot in this lowest position as soon as your baby is old enough to sit up

Assembling into sofa



Important note: First tighten all bolts by hand only, do not tighten all bolts with Allen Key until all parts have been fully assembled.

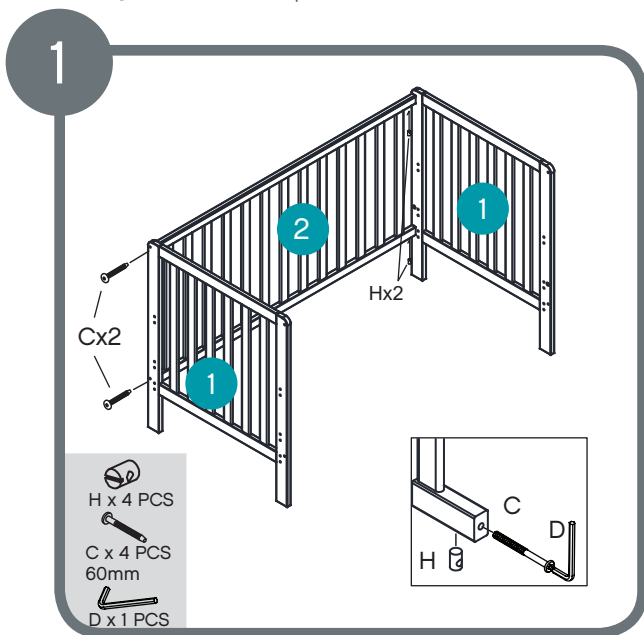

Assemble the 2 ends with fixed rail using 4 x C bolts

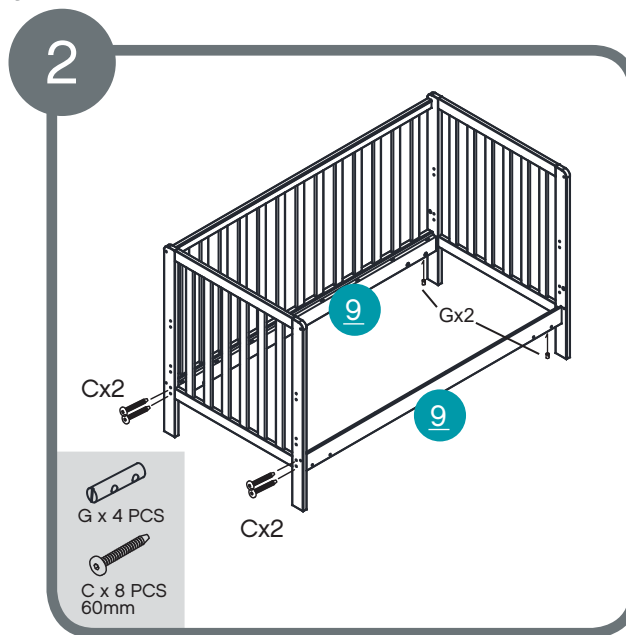

Assemble mattress support bar using 8 x C bolts

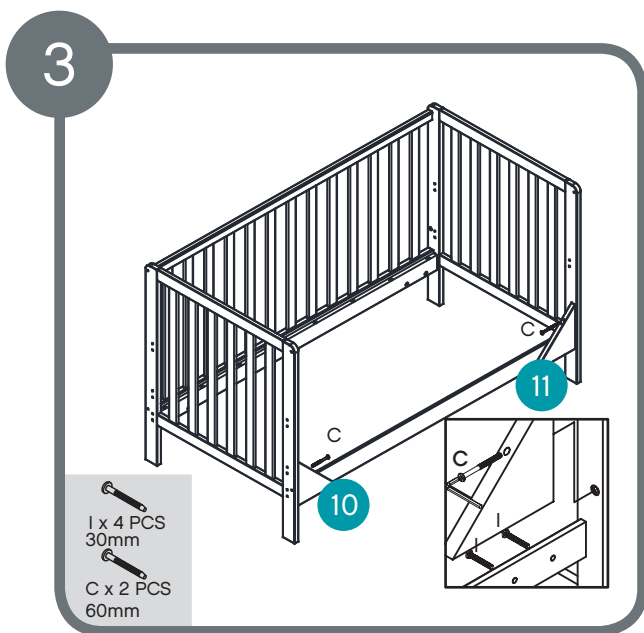

Assemble triangle braces support using 2 x C bolts and 4 x I bolts

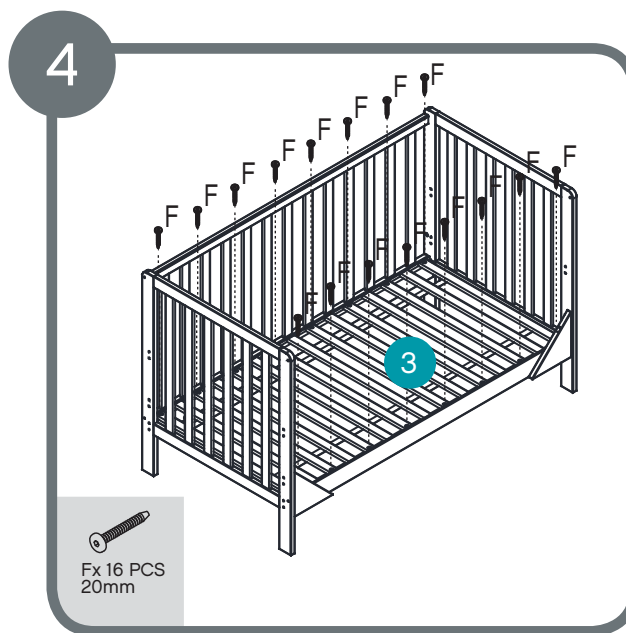

Assemble mattress base using 16 x F bolts



Assembling into bed



Important note: First tighten all bolts by hand only, do not tighten all bolts with Allen Key until all parts have been fully assembled.

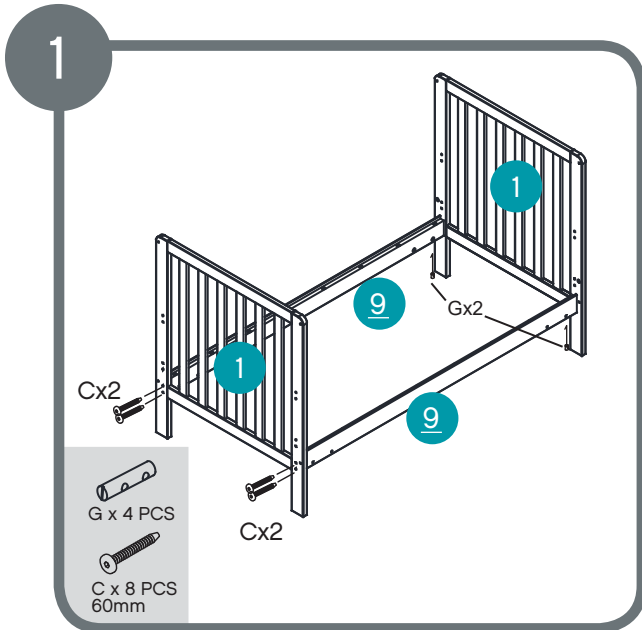

Assemble the 2 ends with fixed rail using 4 x C bolts

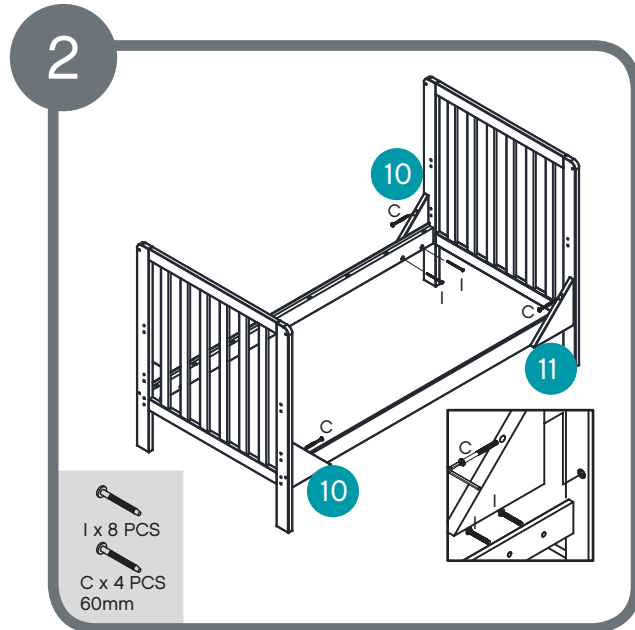

Assemble triangle braces support using 4 x C bolts and 8 x I bolts

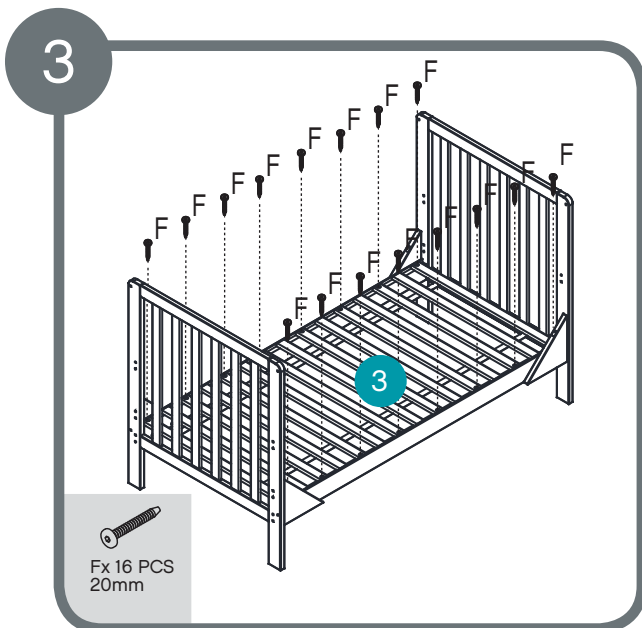

Assemble mattress base using 16 x F bolts

Safety advice and maintenance

IMPORTANT! KEEP FOR FUTURE REFERENCE: READ CAREFULLY

1. The safety of your child is your responsibility.
2. The bottom mattress base position is the safest. You should always use the cot in this lowest position as soon as your baby is old enough to sit up.
3. WARNING: Do not leave anything in the cot or place the cot close to another product, which could provide a foothold or present a danger of suffocation or strangulation, e.g. strings, blind/curtain cords etc.
4. When choosing mattress, ensure that the height between the surface of the mattress and the top edge of the cot side is at least 50cm for the lowest position and 20cm in the upper position.
5. There should never be a gap of more than 3cm between the mattress and the sides or ends of the cot.
6. Regularly check that nuts and bolts are secure or evidence of damage, which could make the bed unsafe. Loose fittings can result in snagging clothes or cords posing a risk of strangulation.
7. The maximum height (i.e. upper surface) of any mattress fitted must not exceed safety mark engraved on the inside of the cot end.
8. We recommend the use of Tutti Bambini mattress for this cot bed or a minimum mattress measuring 70cms x 140cm.
9. WARNING: Do not use more than one mattress in the cot. Do not use a mattress with a depth greater than 100mm.
10. Clean with a damp cloth, do not use abrasives or bleach.
11. WARNING: Do not use the cot if any part is broken, torn or missing and use only spare parts approved by Tutti Bambini.
12. To prevent child injury from falls, the cot should not be used when a child can climb out from the cot.
13. Excessive chewing may damage the wood and cause splintering. If any part is damaged, stop using the cot until the correct part has been replaced.
14. WARNING: Be aware of the risk of open fire and other sources of strong heat, such as electric bar fires, gas fires etc in the near vicinity of the cot.
15. All assembly fittings should always be tightened properly and fittings should be checked regularly and re-tightened as necessary.
16. The cot bed is intended for use for children from birth to approximately 4 years of age. The child's bed is suitable for children who have outgrown the cot (approximately 18 months) up to the age of 4 years. the cot can also be used as a sofa.
17. WARNING: Do not place this child's bed near heat sources, windows and other furniture.
18. Children are likely to play, bounce, jump and climb on beds, therefore the child's bed should not be placed too close to other furniture or windows, blind cords, curtain pulls or other strings or cords, and should be placed either tight to any wall or have a gap of 300mm between the wall and the side of the bed.
19. This cot bed is designed to be dismantled for storage or transportation.
20. There should never be a gap of more than 30mm between the mattress and side or the ends of the cot. Product development dictates that components may occasionally differ from the ones shown in the diagrams of these instructions. The right to change the specifications and design of the furniture without prior notice remains with the manufacturer.
21. Any additional or replacement parts are obtained from the Tutti Bambini or its distributor.

Guarantee

All our products are produced from the finest quality materials and are manufactured under the strictest quality controls. We guarantee all our products or parts thereof against faulty manufacture for a period of one year from date of purchase. This guarantee is not effective against accidental damage or damage caused by incorrect use or neglect. This does not affect your statutory rights.

This product has been designed and manufactured to EN 716:2017+AC:2019 and BS 8509:2008+A1:2011 and EN 12221:2008+A1:2013.

Notes

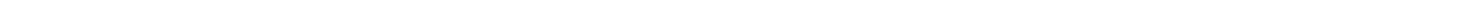
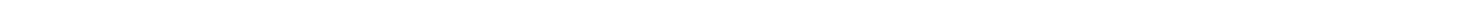
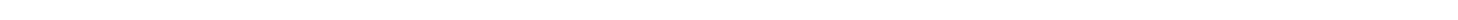
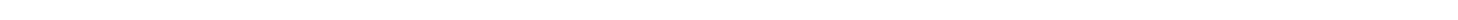
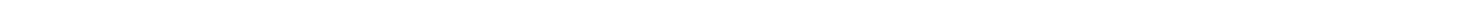
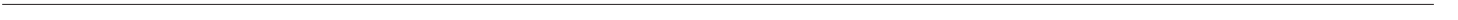

Join Us



Follow us on Facebook
TuttiBambiniUK



Follow us on Twitter
TuttiBambiniUK



Follow us on Instagram
TuttiBambiniUK

TUTTI
bambini 

www.tuttibambini.com